

Hybrid Stepper Motor

KL34H260-42-8A

UNIT=MM:

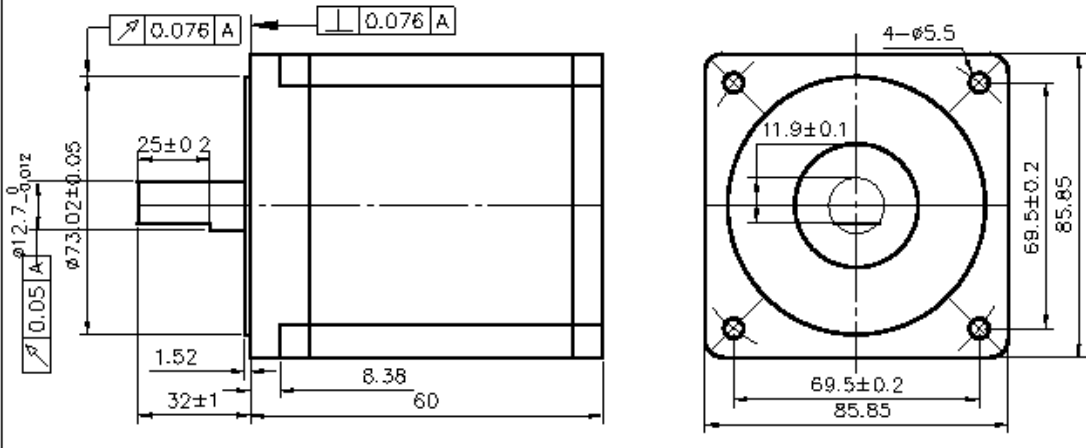

STEP ANGLE	CONNECTION STYLE	CURRENT	RESISTANCE	INDUCTANCE	HOLDING TORQUE	ROTOR INERTIA	WEIGHT
DEG/STEP		A	ohms	mH	OZ-IN	gcm ²	Kg
1.8	Parallel	6	0.27	1.85	465	1000	1.7
	Series	3	1.08	6.6			
	Unipolar	4.2	0.54	1.85	282		

