

GDF60-18Z/4.5 220V Outline diagram

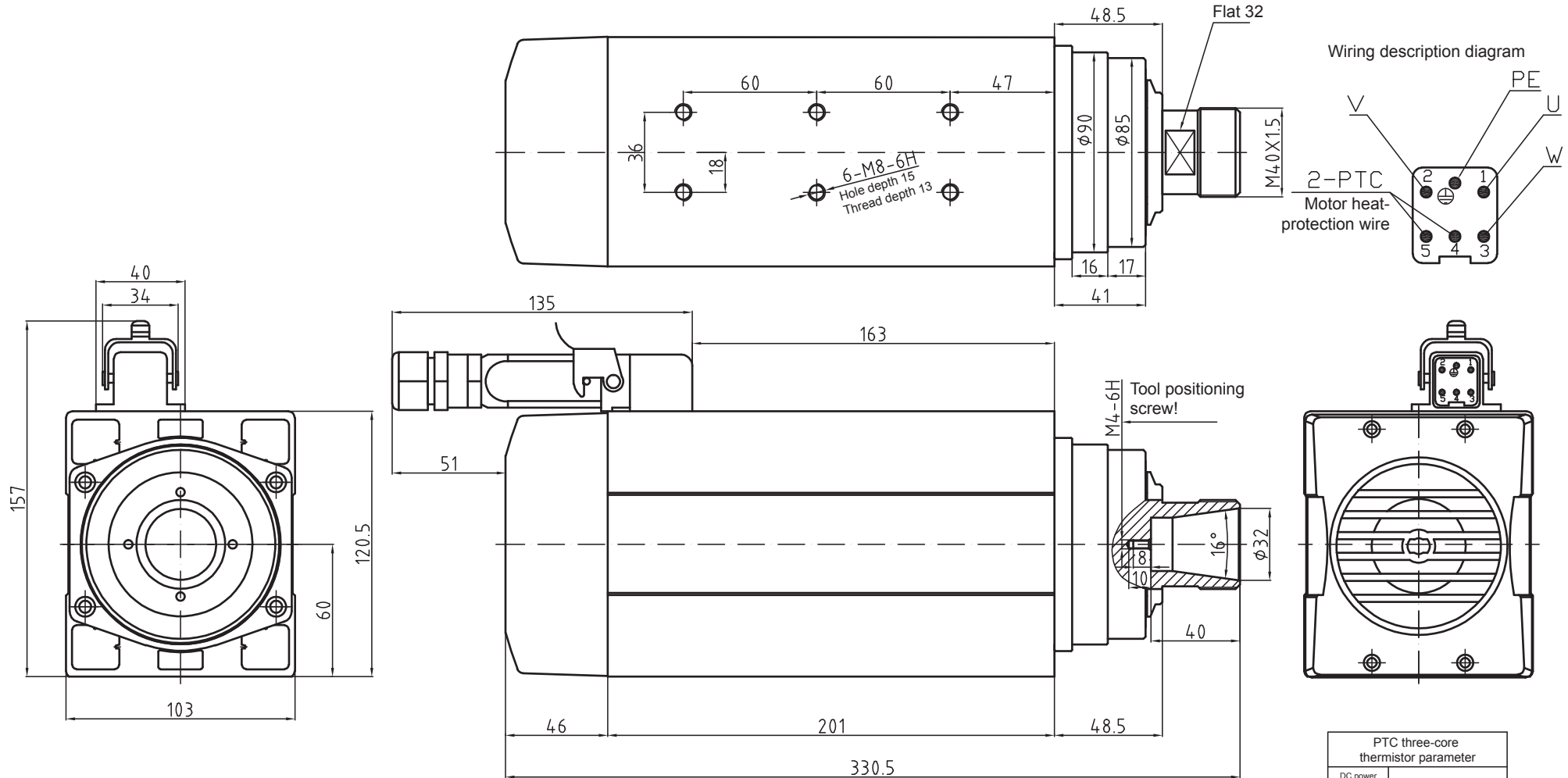

GDF60-18Z/4.5

Power	4.5 kw	Weight: 12KG
Voltage	220 V	ER nut: ER32
Current	15.0 A	Cooling method: air cooling
Frequency	300 Hz	Bearing lubrication method: grease lubrication
Rotating speed	18000 r/min	High-precision angular contact ball bearing: 2×7008C P4/2×7002C P4

Rotating direction: anticlockwise from the shaft extension end

Special attention: thread locking adhesive shall be applied or the spring washer shall be added to prevent the looseness during the installation of the fastening screw!

PTC three-core thermistor parameter	
DC power supply	Maximum DC25V/100mA
-20~25℃	≤300Ω
≤90℃	≤750Ω
105℃	≤1650Ω
110℃	Rated operating temperature
115℃	≥3990Ω
≥125℃	≥12KΩ
≤160℃	Maximum storage temperature